













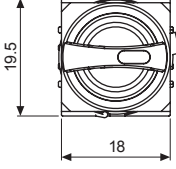

Ø16 Round Selector Switches (S16SR Series)

Type	Appearance	Operating position		Model	Contact block	LED block
					C contact	DC voltage
Standard short lever, extended	 <p>S16SR-S1W□</p>	2-position, spring return		S16SR-S1□C	1	-
				S16SR-S1□2C	2	
		2-position, maintained		S16SR-S2□C	1	
				S16SR-S2□2C	2	
		3-position, spring return two-way		S16SR-S3□2C	2	
		3-position, maintained		S16SR-S4□2C	2	
3-position, spring return from right		S16SR-S5□2C	2			
3-position, spring return from left		S16SR-S6□2C	2			
<p>※□ indicates color: R, B, G, Y, W</p> <p>※The control unit, contact blocks, LED blocks are sold separately. (control unit: bold letters, contact block: regular letters)</p> <p>※Connect up to 2 contact blocks. Connect the contact blocks only on the right and left side slots. It will not operate if connected to the center slot.</p>						
<p>• Dimensions (unit: mm)</p>  <p>※For panel cut-out dimensions, please refer to page A-48.</p>						

Type	Appearance	Operating position	Model	Contact block		LED block
				C contact	DC voltage	
Standard short lever, extended (illuminated)		2-position, spring return		S16SR-L1□C5	1	1 (5VDC)
				S16SR-L1□C12		1 (12VDC)
				S16SR-L1□C24		1 (24VDC)
			S16SR-L1□2C5	2		1 (5VDC)
			S16SR-L1□2C12			1 (12VDC)
			S16SR-L1□2C24			1 (24VDC)
		2-position, maintained		S16SR-L2□C5	1	1 (5VDC)
				S16SR-L2□C12		1 (12VDC)
				S16SR-L2□C24		1 (24VDC)
			S16SR-L2□2C5	2		1 (5VDC)
			S16SR-L2□2C12			1 (12VDC)
			S16SR-L2□2C24			1 (24VDC)
		3-position, spring return two-way		S16SR-L3□2C5	2	1 (5VDC)
				S16SR-L3□2C12		1 (12VDC)
				S16SR-L3□2C24		1 (24VDC)
		3-position, maintained		S16SR-L4□2C5	2	1 (5VDC)
				S16SR-L4□2C12		1 (12VDC)
				S16SR-L4□2C24		1 (24VDC)
		3-position, spring return from right		S16SR-L5□2C5	2	1 (5VDC)
				S16SR-L5□2C12		1 (12VDC)
				S16SR-L5□2C24		1 (24VDC)
		3-position, spring return from left		S16SR-L6□2C5	2	1 (5VDC)
				S16SR-L6□2C12		1 (12VDC)
				S16SR-L6□2C24		1 (24VDC)

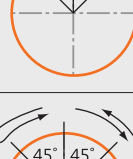
※□ indicates color: **R**, **B**, **G**, **Y**, **W**

※The control unit, contact blocks, LED blocks are sold separately.

(control unit: bold letters, contact and LED block: regular letters)

※Connect up to 2 contact blocks. Connect the contact blocks only on the right and left side slots.

It will not operate if connected to the center slot.

※The LED color is the same as the control unit.

• Dimensions

(unit: mm)

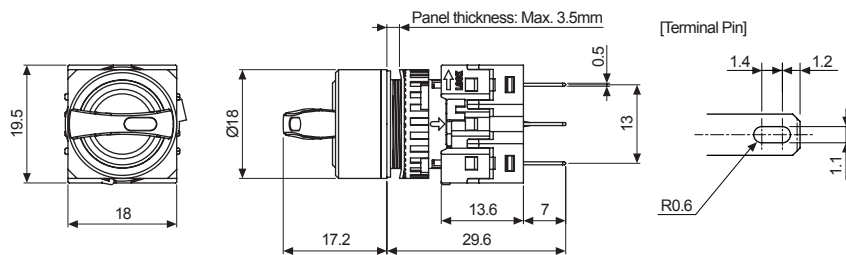











※For panel cut-out dimensions, please refer to page A-48.

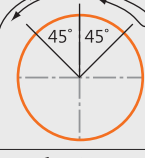
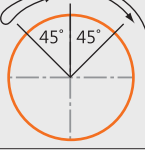
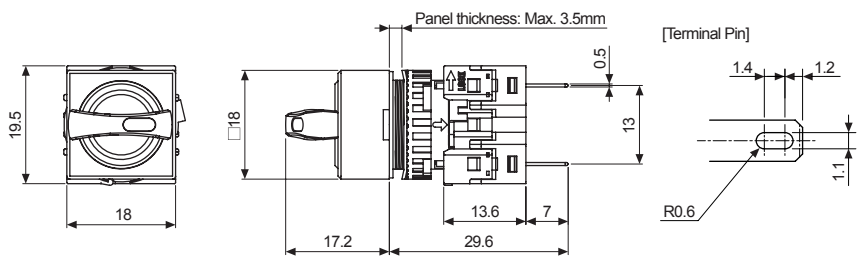
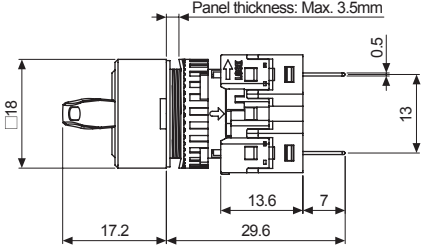
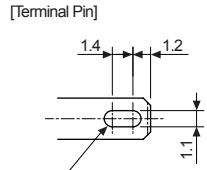

Ø16 Selector Switches

Ø16 Square Selector Switches (S16SRS Series)

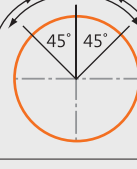
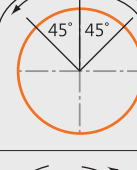
Type	Appearance	Operating position		Model	Contact block	LED block
					C contact	DC voltage
Standard short lever, extended	 <p>S16SRS-S1W</p>	2-position, spring return		S16SRS-S1□C	1	
				S16SRS-S1□2C	2	
		2-position, maintained		S16SRS-S2□C	1	
				S16SRS-S2□2C	2	
		3-position, spring return two-way		S16SRS-S3□2C	2	
		3-position, maintained		S16SRS-S4□2C	2	
3-position, spring return from right		S16SRS-S5□2C	2			
3-position, spring return from left		S16SRS-S6□2C	2			
<p>※□ indicates color: ■, ■, ■, ■, ■</p> <p>※The control unit, contact blocks, LED blocks are sold separately. (control unit: bold letters, contact block: regular letters)</p> <p>※Connect up to 2 contact blocks. Connect the contact blocks only on the right and left side slots. It will not operate if connected to the center slot.</p>						
<p>• Dimensions (unit: mm)</p> <div style="display: flex; justify-content: space-around; align-items: flex-start;"> <div style="text-align: center;">  <p>19.5 18</p> </div> <div style="text-align: center;">  <p>Panel thickness: Max. 3.5mm 17.2 13.6 29.6 7</p> </div> <div style="text-align: center;">  <p>[Terminal Pin] 1.4 1.2 1.1 R0.6</p> </div> </div> <p style="text-align: right;">※For panel cut-out dimensions, please refer to page A-48.</p>						

Type	Appearance	Operating position	Model	Contact block		LED block		
				C contact	DC voltage			
Standard short lever, extended (illuminated)		2-position, spring return		S16SRS-L1□C5 S16SRS-L1□C12 S16SRS-L1□C24	1	1 (5VDC)		
						S16SRS-L1□2C5 S16SRS-L1□2C12 S16SRS-L1□2C24	2	1 (12VDC)
								1 (24VDC)
			1 (5VDC)					
			2-position, maintained		S16SRS-L2□C5 S16SRS-L2□C12 S16SRS-L2□C24	1	1 (12VDC)	
							S16SRS-L2□2C5 S16SRS-L2□2C12 S16SRS-L2□2C24	2
		1 (5VDC)						
		1 (12VDC)						
		3-position, spring return two-way			S16SRS-L3□2C5 S16SRS-L3□2C12 S16SRS-L3□2C24	2	1 (5VDC)	
							1 (12VDC)	
			1 (24VDC)					
		3-position, maintained		S16SRS-L4□2C5 S16SRS-L4□2C12 S16SRS-L4□2C24	2	1 (5VDC)		
						1 (12VDC)		
						1 (24VDC)		
		3-position, spring return from right		S16SRS-L5□2C5 S16SRS-L5□2C12 S16SRS-L5□2C24	2	1 (5VDC)		
						1 (12VDC)		
						1 (24VDC)		
		3-position, spring return from left		S16SRS-L6□2C5 S16SRS-L6□2C12 S16SRS-L6□2C24	2	1 (5VDC)		
						1 (12VDC)		
						1 (24VDC)		

※□ indicates color: R, B, G, Y, W

※The control unit, contact blocks, LED blocks are sold separately.
(control unit: bold letters, contact and LED block: regular letters)

※Connect up to 2 contact blocks. Connect the contact blocks only on the right and left side slots.
It will not operate if connected to the center slot.

※The LED color is the same as the control unit.

• Dimensions (unit: mm)

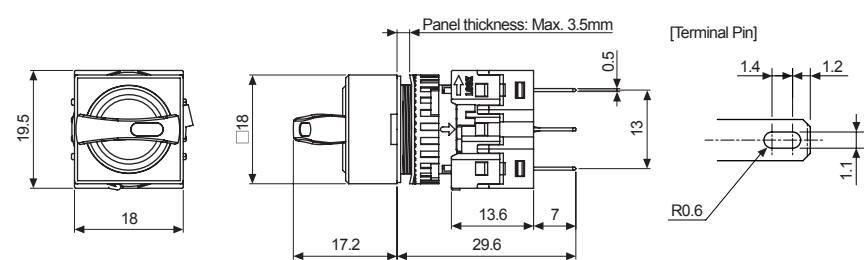







※For panel cut-out dimensions, please refer to page A-48.



Ø16 Selector Switches

Ø16 Rectangular Selector Switches (S16SRT Series)

Type	Appearance	Operating position	Model	Contact block	LED block
				C contact	DC voltage
Standard short lever, extended	 <p>S16SRT-S1W□</p>	2-position, spring return 	S16SRT-S1□C	1	-
			S16SRT-S1□2C	2	
		2-position, maintained 	S16SRT-S2□C	1	
			S16SRT-S2□2C	2	
		3-position, spring return two-way 	S16SRT-S3□2C	2	
		3-position, maintained 	S16SRT-S4□2C	2	
3-position, spring return from right 	S16SRT-S5□2C	2			
3-position, spring return from left 	S16SRT-S6□2C	2			

※□ indicates color: **R**, **B**, **G**, **Y**, **W**

※The control unit, contact blocks, LED blocks are sold separately.
(control unit: bold letters, contact block: regular letters)

※Connect up to 2 contact blocks. Connect the contact blocks only on the right and left side slots.
It will not operate if connected to the center slot.

• Dimensions

(unit: mm)

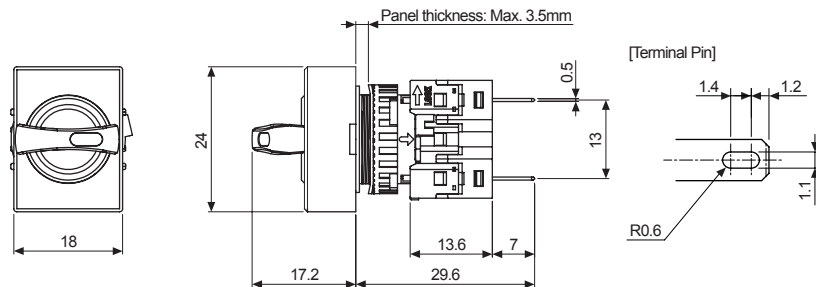

※For panel cut-out dimensions, please refer to page A-48.

Type	Appearance	Operating position	Model	Contact block		LED block	
				C contact	DC voltage		
Standard short lever, extended (illuminated)		2-position, spring return	S16SRT-L1□C5	1	1	1 (5VDC)	
			S16SRT-L1□C12			1 (12VDC)	
			S16SRT-L1□C24			1 (24VDC)	
			S16SRT-L1□2C5			2	1 (5VDC)
			S16SRT-L1□2C12				1 (12VDC)
			S16SRT-L1□2C24				1 (24VDC)
		2-position, maintained	S16SRT-L2□C5	1	1 (5VDC)		
			S16SRT-L2□C12		1 (12VDC)		
			S16SRT-L2□C24		1 (24VDC)		
			S16SRT-L2□2C5	2	1 (5VDC)		
			S16SRT-L2□2C12		1 (12VDC)		
			S16SRT-L2□2C24		1 (24VDC)		
		3-position, spring return two-way	S16SRT-L3□2C5	2	1 (5VDC)		
			S16SRT-L3□2C12		1 (12VDC)		
			S16SRT-L3□2C24		1 (24VDC)		
		3-position, maintained	S16SRT-L4□2C5	2	1 (5VDC)		
			S16SRT-L4□2C12		1 (12VDC)		
			S16SRT-L4□2C24		1 (24VDC)		
		3-position, spring return from right	S16SRT-L5□2C5	2	1 (5VDC)		
			S16SRT-L5□2C12		1 (12VDC)		
			S16SRT-L5□2C24		1 (24VDC)		
		3-position, spring return from left	S16SRT-L6□2C5	2	1 (5VDC)		
			S16SRT-L6□2C12		1 (12VDC)		
			S16SRT-L6□2C24		1 (24VDC)		

※□ indicates color: **R**, **B**, **G**, **Y**, **W**
 ※The control unit, contact blocks, LED blocks are sold separately.
 (control unit: bold letters, contact and LED block: regular letters)
 ※Connect up to 2 contact blocks. Connect the contact blocks only on the right and left side slots.
 It will not operate if connected to the center slot.
 ※The LED color is the same as the control unit.

• Dimensions

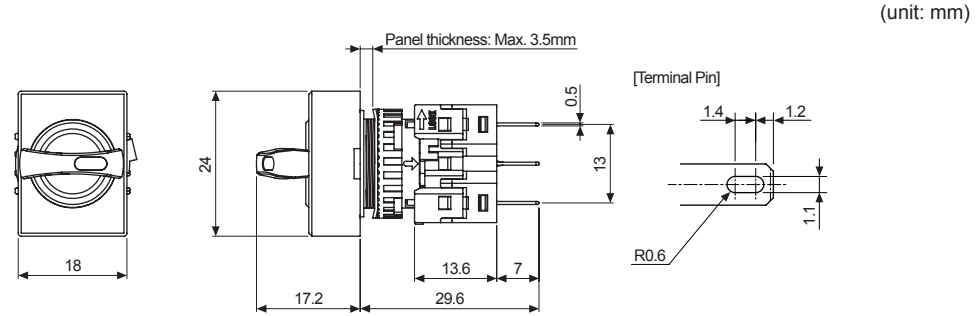









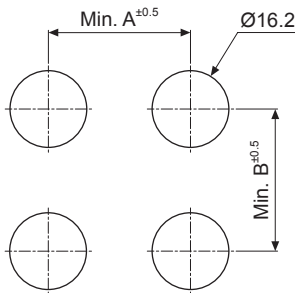





※For panel cut-out dimensions, please refer to page A-48.

Ø16 Panel Cut-out Dimensions

Ø16 Panel Cut-out Dimensions

(unit: mm)

Type			A	B	Panel Cut-out Dimensions
Push Button Switches	Round (S16PR Series)		20	21	
	Square (S16PRS Series)		20	21	
	Rectangular (S16PRT Series)		25	21	
Selector Switches	Round (S16SR Series)		20	21	
	Square (S16SRS Series)		20	21	
	Rectangular (S16SRT Series)		25	21	
Key Selector Switches	Round (S16KR Series)		20	21	
	Square (S16KRS Series)		20	21	
	Rectangular (S16KRT Series)		25	21	
Mushroom-head Push Button Switches (S16BR Series)			24	24	
Emergency Switches (S16ER Series)			40	40	
Pilot Lights	Round (L16RR Series)		20	21	
	Square (L16RRS Series)		20	21	
	Rectangular (L16RRT Series)		25	21	